

DEVELOPMENT, FABRICATION AND TESTING OF THE RF-KICKER FOR THE ACCULINNA-2 FRAGMENT SEPARATOR

W. Beeckman*, F. Forest, O. Tasset, E. Voisin, SIGMAPHI, Vannes, France
A. Bechtold, NTG Neue Technologien GmbH & Co KG, Gelnhausen, Germany
A. Fomichev, A. Gorshkov, S. Krupko, G. Ter-Akopian
Flerov Laboratory of Nuclear Reactions, JINR, ubna, Russia

Abstract

The Acculina-2 radioactive beam separator was designed and built between 2012 and 2014, installed and tested by Sigmaphi in 2015 and in full operation since 2016 at the Flerov laboratory of JINR in Dubna. In order to achieve efficient separation of neutron-deficient species, an RF kicker was foreseen since the beginning of the project but was put on hold for many years.

In 2016 Sigmaphi got a contract to study, build, install and test an RF kicker with a variable frequency ranging between 15 and 21 MHz and producing 15kV/cm transverse electric fields in a 10 cm gap over a 1m distance.

The paper briefly recalls the rationale of an RF-kicker to separate neutron-deficient species. It then goes through the different steps of the study, initial choice of the cavity structure, first dimensioning from analytical formulas, finite elements computations and tuning methods envisioned, down to a final preliminary design.

The fabrication and tests of a 1/10 mock-up and final study, design, construction and factory testing of the real cavity are presented but, because of U400M cyclotron closure, no beam tests have been performed so far.

INTRODUCTION

A detailed description of the Acculina-2 RI beam separator and a comparison with other separators can be found in [1–3] and references therein. The purpose of the RF kicker in the Acculina-2 separator is outlined in [2] and with more details in [3], which, as a review paper, provides a very complete panorama of intended experiments with Acculina-2.

In the present paper, we describe the design, fabrication, installation and testing of the RF kicker. The choice of Sigmaphi by JINR is the continuation of the long-time collaboration during which Sigmaphi studied, built, installed and helped starting a large part of the Acculina-2 facility.

The reader will find information on the rationale for RF kickers for RIB beamlines in references [4–6] and we only briefly summarize them here for consistency. Proton-rich (aka neutron-deficient) isotopes, are difficult to separate because

- being close to the dripline, they are usually produced with very low yields.
- their magnetic rigidity $B\Delta$ is similar to the rigidity of the low energy tail of species close to the stability zone, which are produced in much larger quantities. Hence, they are shadowed by a more intense background and magnetic separation is inefficient.

However, these “magnetically entangled” species differ in their velocities v , hence in the time TOF it takes for them to travel the distance D between their point of production and a further away location in the beamline.

$$B\rho = \left(\frac{p}{Qq}\right) = \left(\frac{mv}{q}\right) \left(\frac{A}{Q}\right) = \frac{1}{TOF} \left(\frac{Dm}{q}\right) \left(\frac{A}{Q}\right),$$

$$TOF = \left(\frac{Dm}{B\rho q}\right) \left(\frac{A}{Q}\right) = C^{ste} \left(\frac{A}{Q}\right).$$

In the case of fully stripped ions, we have

$$TOF = C^{ste} \left(\frac{Z+N}{Z}\right) = a + \frac{b}{Z},$$

a and b being 2 constants, which we can summarize as: For the same number of neutrons and identical rigidities, the time-of-flight increases as atomic number decrease.

Every such “TOF-different” component of the beam enters the kicker at a different time and experiences inside it a different vertical electric field, kicking some components up, some down -and any in-between- according to the time structure of the beam and that of the electric field. After some drifting distance, the vertical kick is transformed into a vertical distance to the optical axis and a suitable set of slits and vertical steering magnets allow selecting the part of the beam one is interested in. An RF-kicker/deflector/sweeper is a TOF to vertical deflection transformer.

SCOPE OF WORK

- Cavity design: variable frequency and high mechanical and thermal stability, cooling, vacuum pumps and gauges.
- Motorized coupling, tuning and fine-tuning loops, measuring pick-up loops
- Cavity fabrication and factory tests
- RF generator and amplifier
- Command and control system
- On-site start-up and tests

CAVITY DESIGN

Most requirements are given in Table 1 (identical required and achieved values), to which we must add maximum height of 2300 mm and weight of 3000 kg. See also graphical summary of these parameters in Fig. 1.

The dimensional constraints advocate for a quarter-wave coaxial resonator, a cavity of a similar type as the one built for RIBF [7]. Analytical formulas for such a simple geometry e.g. [8] permit fast preliminary estimates.

In order to address the frequency change in the rather large requested range, modifying the inductance, the capacitance or a mix of both were envisioned.

Changing the inductance requires a sliding short-circuited plate around the central pillar that reduces the cavity length

* wbeeckman@sigmaphi.fr

Content from this work may be used under the terms of the CC BY 4.0 licence (© 2022). Any distribution of this work must maintain attribution to the author(s), title of the work, publisher, and DOI

Table 1: Comparison of Kicker Parameters in the RIBF [7], Acculinn-2 and NSCL [9] Facilities

Parameter	RIBF	Acc-2	NSCL
Type	$\lambda/4$	$\lambda/4$	$\lambda/2$
Length [mm]	1600	1650	1500
R_{cavity} [mm]	800	1400	
$L_{electrode}$ [mm]	700	700	1500
$w_{electrode}$ [mm]	120	120	
gap [mm]	40	70	50
V [kV]	100	120	100
f_{low} [MHz]	11	14.8	19
f_{high} [MHz]	19	22.7	27
Q_{low}	13000	13200	7500*
Q_{high}	18000	16600	10000*

* Most pessimistic - different papers present different values

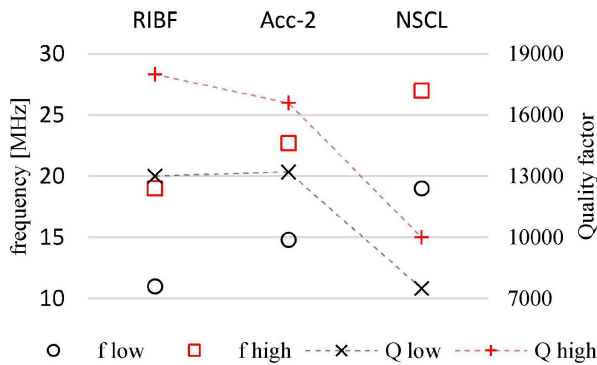

Figure 1: Comparison of frequency ranges and quality factors for 3 RF-kickers with comparable goals, showing a nice match to the trend of the Acculinn-2 kicker.

but the frequency range involved requires a 600 mm stroke which makes it mechanically complex and, moreover, it influences other functions as the possibility to insert the coupling loop, pick-ups and pumping from the top.

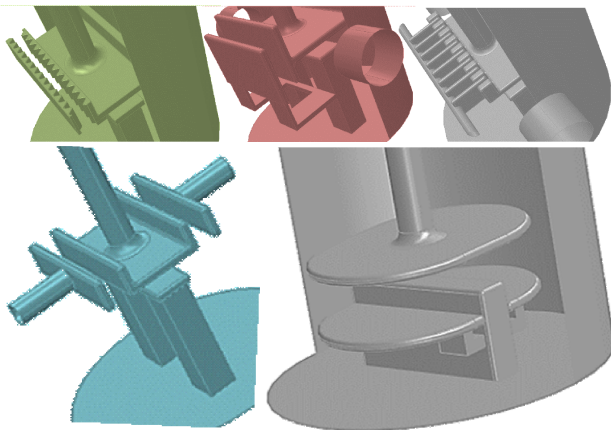

Figure 2: Many different geometries for capacitive change were tried, among which a few examples are shown (top row and bottom left). The chosen solution is displayed in the bottom right-hand part of the picture.

A capacitive method looks easier, being located in the vicinity of the electrodes and therefore having little influence on other functions but care must be taken to preserve a good field pattern in the gap. A rather large space is needed to cover the whole range.

The capacitive solution is also the one chosen for other existing kickers [5, 7, 9]. Figure 2 shows a series of Soprano (Opera3d RF module) models with different solutions for the capacitance modification. The chosen solution is also displayed. Although the RIBF cavity [7] has a geometry close to ours, we preferred keeping a fully cylindrical geometry instead of a mixed cylinder/rectangle to avoid close unwanted modes and make construction easier.

A design featuring an inductively modified frequency through magnetically saturable ferrite rings in an external magnetic field was also envisioned but, despite a very attractive reduced size (Fig. 3), it was judged too radical.

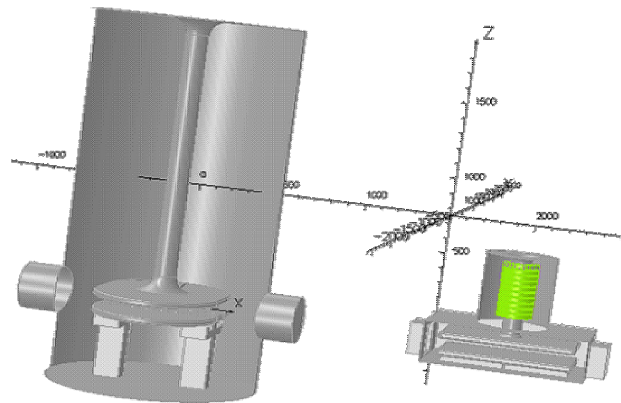

Figure 3: Soprano models of the conventional version using capacitive tuning (15-22 MHz) and of the version with saturable ferrite inductive tuning (15-45 MHz) are displayed on the same scale.

MOCK-UP TESTS

We built a 1/10 scale model of the cavity with which we could check calculation results as shown in Fig. 4.

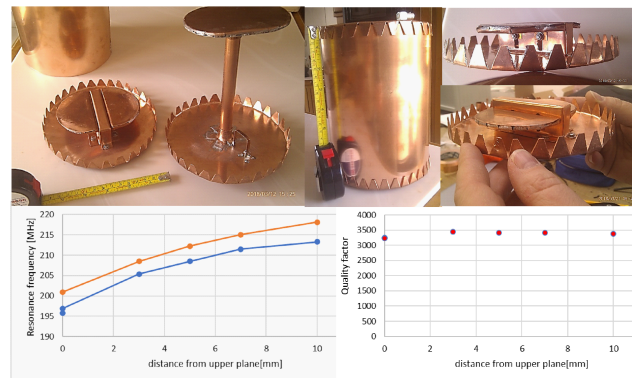

Figure 4: A 1/10 scale mock-up (top) was used to check Soprano predictions as frequency variation vs distance of the tuning plates (bottom left) and a low sensitivity of the coupling to this distance (bottom right).

The discrepancies between calculations and mock-up come from slightly different geometries from the use of commercially available copper parts, inaccuracies in the measurement of the gap (0.5 mm is enough), openings not taken into account, etc. Other important lessons were learned, among others on coupling.

CAVITY FABRICATION

The NTG company was contracted to build the cavity according to the preliminary design provided by Sigmaphi. A full cross-check using another code (CST Microwave Studio) was performed, as well as a detailed study of all sub-components like sliding contacts, coarse and fine tuners, pick-up probes, etc. (see Fig. 5). Mechanical stability, deformations, thermal and cooling issues were also addressed.

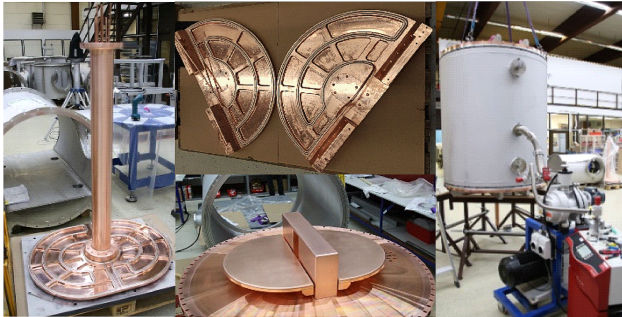

Figure 5: Cavity parts during fabrication. Central pillar and top electrode (left), moving bottom electrodes disassembled (mid top) and assembled with the central electrode on the bottom main flange (mid bottom), with outside drum at the rear of the picture. The right-hand picture shows the complete cavity under vacuum tests.

An examples of factory tests results is show in Fig. 6.

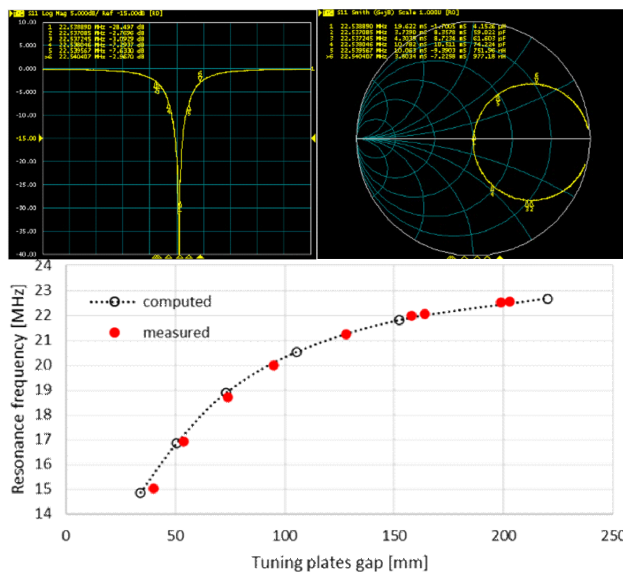

Figure 6: Factory tests results. Top pictures show the resonance peak (left) and Smith chart (right) at 22.539 MHz. At bottom measured and calculated values of the resonance frequency as a function of the distance between the bottom moving electrodes and their top counterpart.

The transmission peak measured at 22.539 MHz delivers a quality factor $Q_{\text{meas}} = 14818$ in almost perfect agreement (<4%) with the calculated value $Q_{\text{calc}} = 14256$ while the Smith chart shows an almost ideal coupling. We also see that measurements and model predictions agree very well on the frequency change generated by moving electrodes throughout the whole tuning range.

POWER AND CONTROL

The kicker is driven by a solid-state HFA-15 RF amplifier from QEI (installed and put in operation by AR France) in CW mode and delivering up to 15 kW in a 14–22 MHz frequency range with a full power bandwidth >200 kHz.

The control system is designed, built and put into operation by Cosylab. It takes care of the full operation of the kicker, from the synchronization with the UM400 cyclotron signal, amplifier set up and power input, coarse and fine frequency tuning, pick-up readings, interlocks, etc.

ON-SITE INSTALLATION AND TESTING

The kicker was rigged in the Acculinna-2 beamline during the 2nd week of June 2019 and full assembly and first test were performed during the last week of July 2019.

A 2 years refurbishment shutdown of the U400M cyclotron which delivers beams to the Acculinna-2 experimental facility was planned by June 2020. Hence, most available beamtime after July 2019 was used by the Acculinna-2 team to collect data to be processed during this 2 years closure period. No further operation was performed on the kicker until a one-week slot was made available in mid-February 2020.

The 2 main goals during this week were to:

- achieve proper coupling in 15-19 MHz range (Figs. 7, 8 and 9).
- overcome multipactoring in the vicinity of 18.0 MHz for first experiments with ^{20}Ne beams.

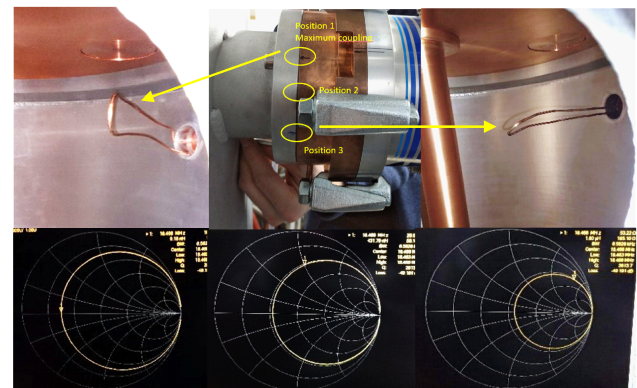

Figure 7: The coupler is rotated in 3 positions defined by the flange. Position 1 (left) gives a strong over-coupling, position 2 (mid) is still over-coupled and position 3 (right) is a bit under-coupled. The loop, in position 3, is then slightly deformed to increase its active surface and reach ideal coupling.

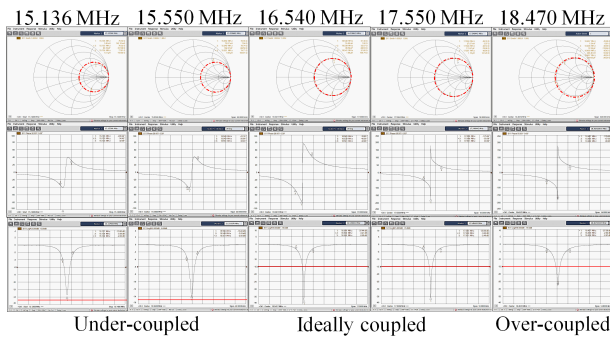

Figure 8: Smith chart (top), phase (mid) and transmission (bottom) for a series of frequencies up to 18.5 MHz. The red line in the bottom part shows the -15 dB value.

Figure 9 compares calculated and measured transmission showing that a better-than-expected transmission is achieved. The coupling must probably be retuned for the high frequency range but the present setting matches at best the cyclotron capabilities.

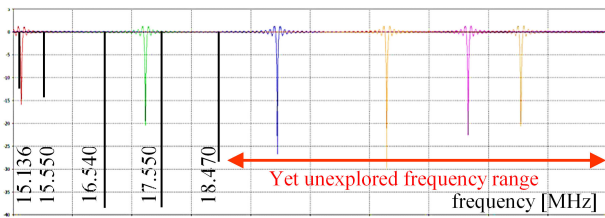

Figure 9: Comparison of calculated (coloured peaks) and measured (black lines and values) transmission (+5 to -40 dB) at a series of frequencies.

To overcome multipactoring, the cavity is conditioned by short sequences of pulses separated by long «blanks». The number of pulses in the sequence is then increased as power is accepted until a continuous signal can be input.

Figure 10 are oscilloscope displays of a 2 ms 900 W impulse (top) and continuous (bottom) signals at 18.4 MHz. The time evolution (left to right) shows a progressive increase of the transmitted (green) and pick-up (pink) signals and a concomitant disappearance of the reflected (blue). Yellow on top is the driving from frequency generator.

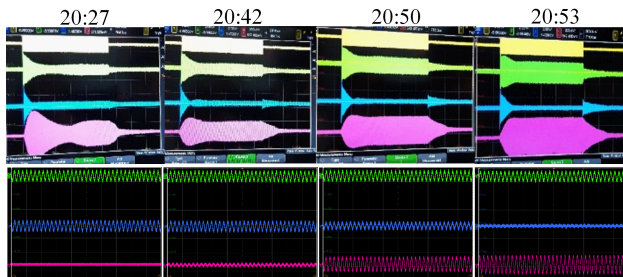

Figure 10: 2 ms 900 W impulse (top) and continuous (bottom) signals at 18.4 MHz. Time of the photo for the impulse signal (top of the picture) shows that conditioning takes place in less than 30 minutes.

Because of the limited time slot, experiments were conducted on a limited frequency range and no test with beam was done yet. U400M operation should resume in the end 2022 and RF-kicker operation will have a high priority in day-one experiments.

CONCLUSION

The Acculinna-2 RF-kicker was successfully designed, built and tested. It is a collaborative achievement.

On-site tests showed equal-to or better-than expected results which we hope to be confirmed in the future operation with beam.

ACKNOWLEDGEMENTS

We want to thank Claude Bieth who unfortunately left us in 2020 for his important advices from the very start of the project. We also thank Bernard Bessot of AR France for his help on power amplifier, Jernej Podlipnik of Cosylab on the control system, Anna Orlova of Sigmaphi Electronics for on-site debugging, Antonio Palmieri of INFN Legnaro for his advices on start-up and multipactoring and Antonio Caruso of INFN Catania for his advices on protection.

REFERENCES

- [1] W. Beeckman *et al.*, “Status of the Acculinna-2 RIB fragment separator”, in *Proc. HIAT 2015*, Yokohama, Japan, 2015, pp. 33-35. doi: 10.18429/JACoW-HIAT2015-M0A2C03
- [2] A. Gorshkov *et al.*, “Current status of the new fragment separator ACCULINNA-2 and the first-day experiments”, *Eurasian J. Phys. Funct. Mater.*, vol. 3, p. 46-52, 2019. doi: 10.29317/ejpfm.2019030106
- [3] A.S. Fomichev, L.V. Grigorenko, S.A. Krupko, S.V. Stepantsov, and G.M. Ter-Akopian, “The ACCULINNA-2 project: The physics case and technical challenges”, *Eur. Phys. J. A*, vol. 54, p. 97-119, 2018. doi: 10.1140/epja/i2018-12528-0
- [4] T. Baumann *et al.*, “The Radio Frequency Fragment Separator: A Time-of-Flight Filter for Fast Fragmentation Beams”, in *Proc. Cyclotrons’13*, Vancouver, BC, Canada, 2013, pp. 467-469. <https://jacow.org/cyclotrons2013/papers/fr1pb03.pdf>
- [5] R.C. Pardo, J. Bogaty, S. Sharamentov, and K.E. Rehm, “An RF beam sweeper for purifying in-flight produced secondary ion beams at ATLAS”, *Nucl. Instr. Methods Phys. Res., Sect. A*, vol. 790, p. 1-5, 2015. doi: 10.1016/j.nima.2015.03.046
- [6] K. Yamada, T. Motobayashi, and I. Tanihata, “RF deflector system for proton-rich RI beams in RIKEN”, *Nucl. Phys. A*, vol. 746, p. 156c-160c, 2004. doi: 10.1016/j.nuclphysa.2004.09.064
- [7] H. Miyazaki, Y. Kumata, and K. Hoshika, “Development of RF deflector”, *Sumitomo Heavy Industries Technical Review*, vol. 153, p. 57-60, Dec. 2003.
- [8] P. Vizmuller, “Resonators – Coaxial resonators”, in *RF Design Guide – Systems, Circuits, and Equations*, Artech House, Norwood, MA, USA: Wiley, 1995, pp. 237-239.
- [9] D. Bazin *et al.*, “Radio Frequency Fragment Separator at NSCL”, *Nucl. Instr. Methods Phys. Res., Sect. A*, vol. 606, p. 314-319, 2009. doi: 10.1016/j.nima.2009.05.100